

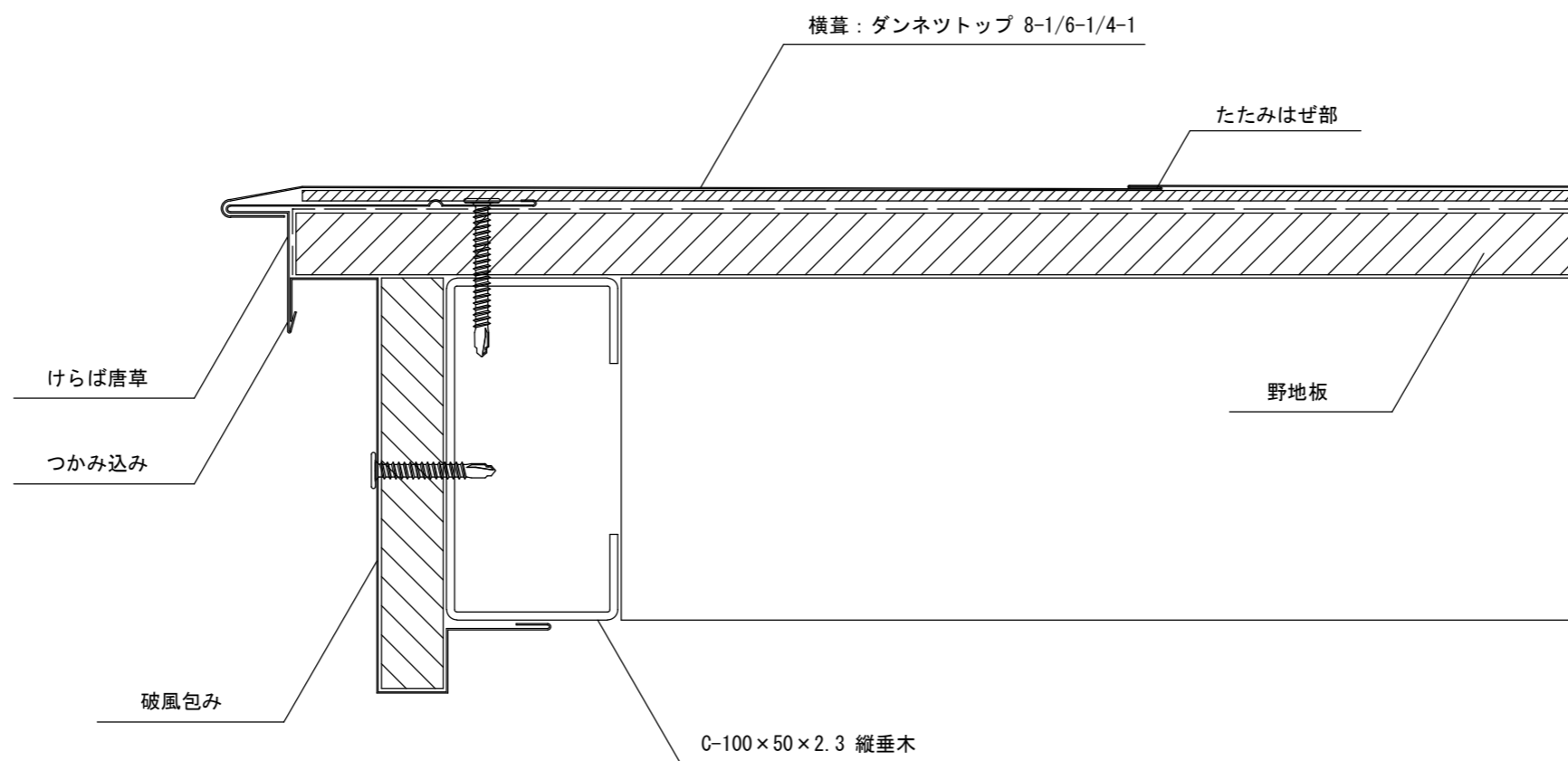

 セキノ興産				年月日	工事名称	図番
						縮尺 A3 : 1/3	図面名 ダンネツトップ 8-1/6-1/4-1 軒先部 (鉄骨) 納め	



		 セキノ興産				年月日	工事名称	図番
						縮尺 A3: 1/2	図面名 ダンネツトップ 8-1/6-1/4-1 けらば部 (鉄骨) 納め	

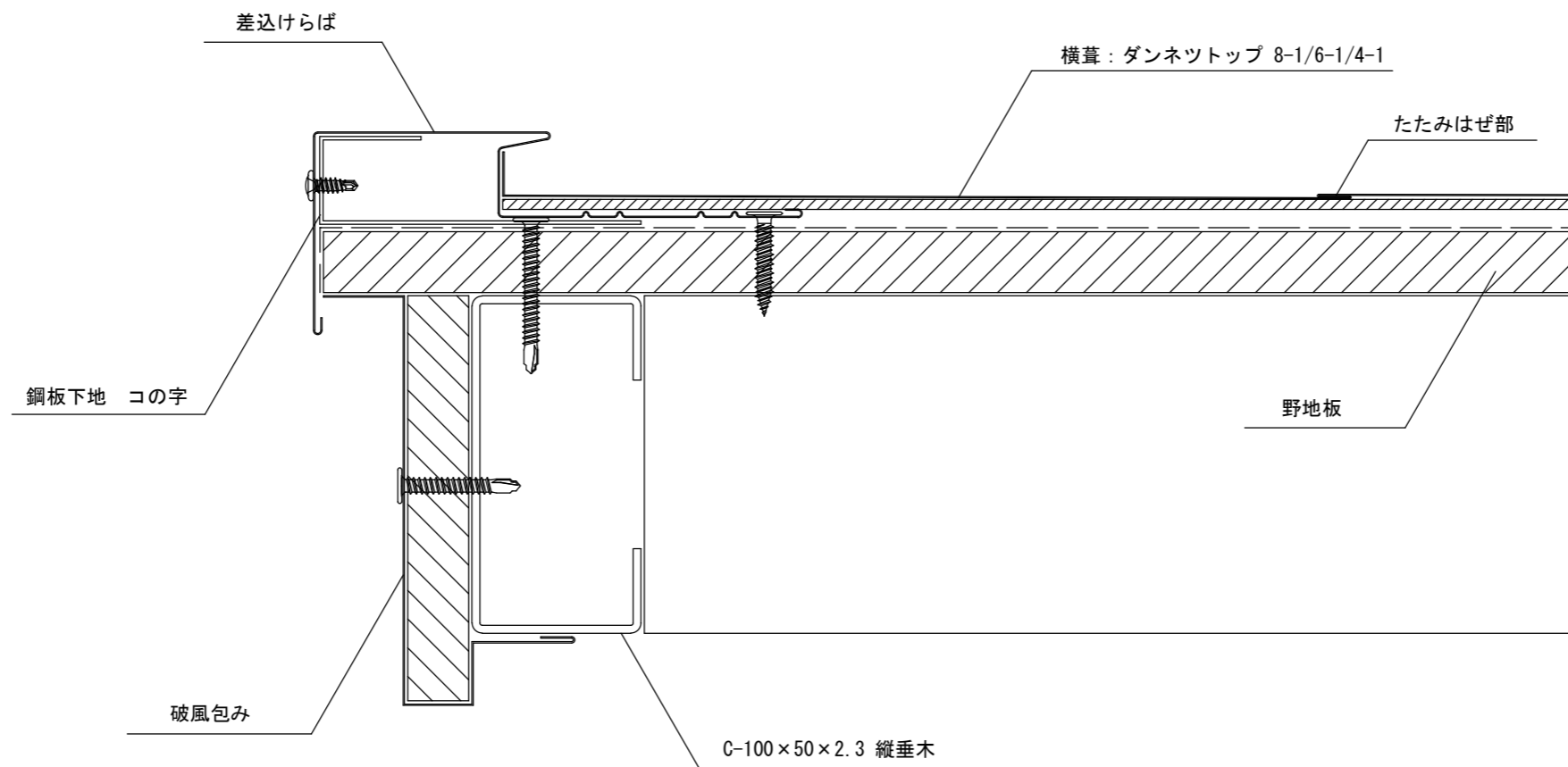

		 セキノ興産				年月日	工事名称	図番
						縮尺 A3 : 1/2	図面名 ダンネツトップ 8-1/6-1/4-1 けらば部 (差込けらば・鉄骨) 納め	

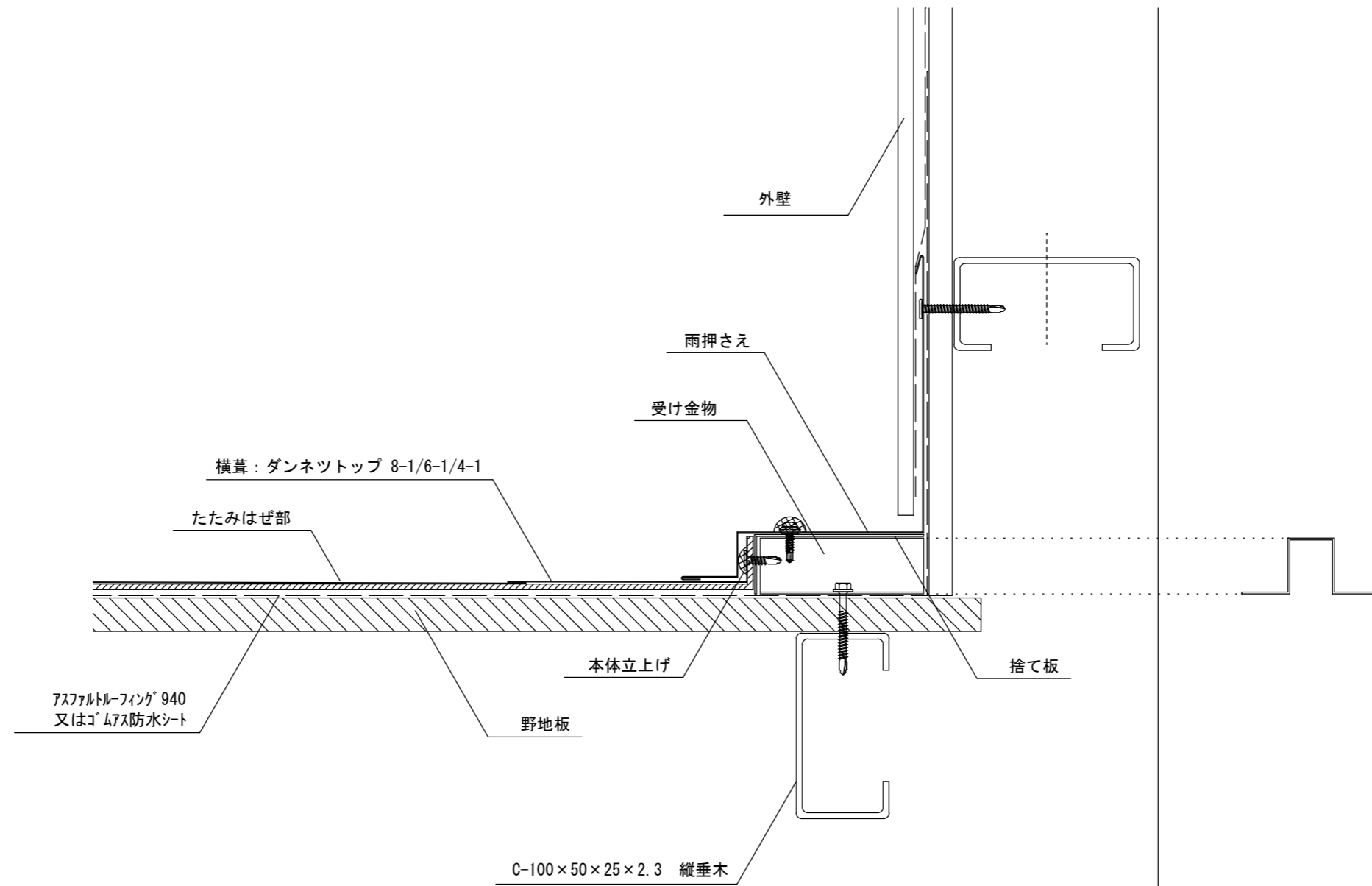

						年月日	工事名称	図番
						縮尺 A3: 1/3	図面名 ダンネツトップ 8-1/6-1/4-1 壁取合部 (流れ方向・鉄骨) 納め	

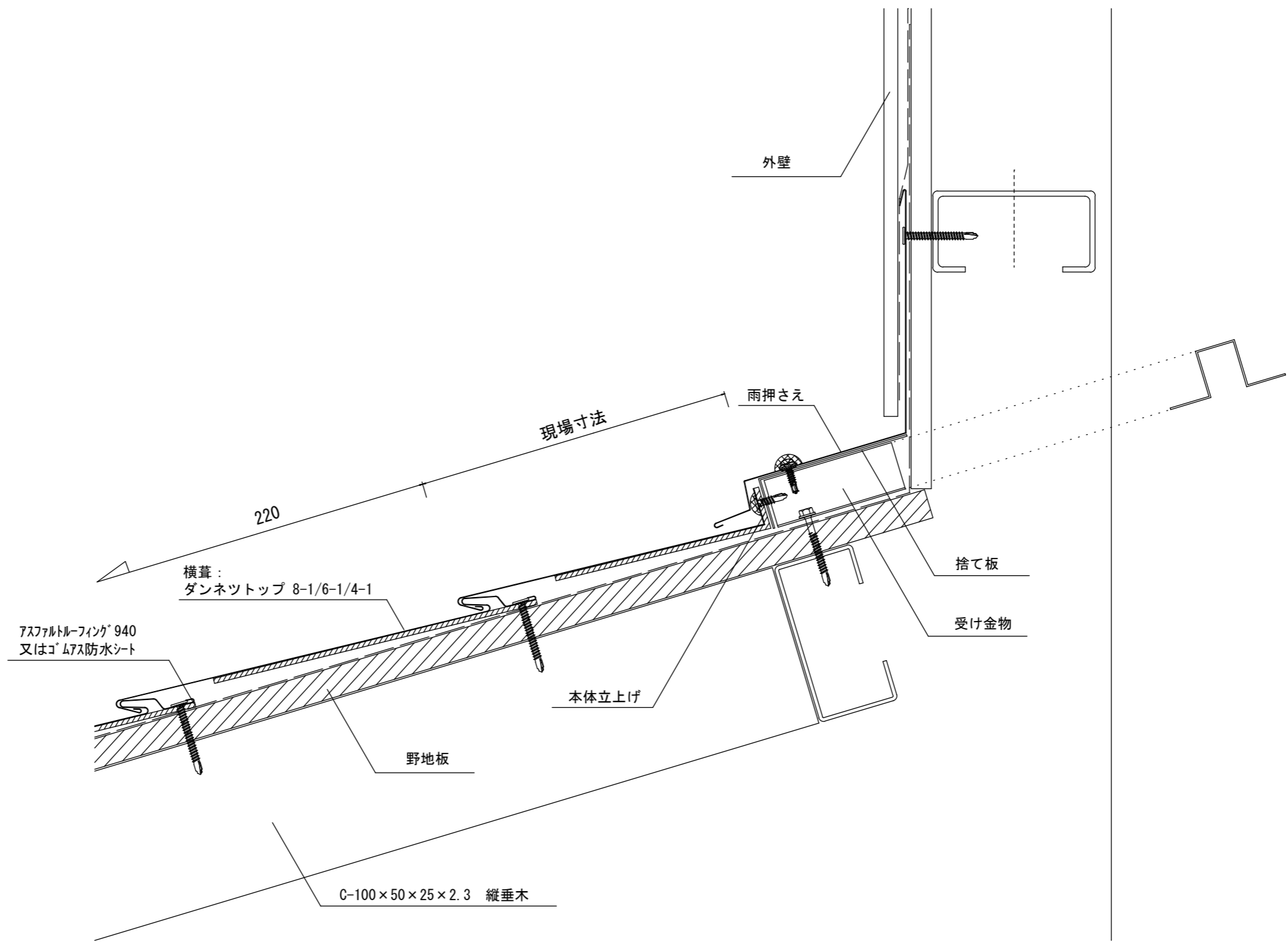
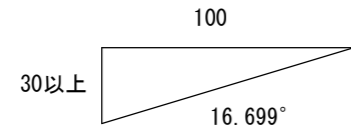

			年月日	工事名称	図番
			縮尺 A3: 1/3	図面名 ダンネットップ 8-1/6-1/4-1 壁取合部 (水平方向・鉄骨) 納め	

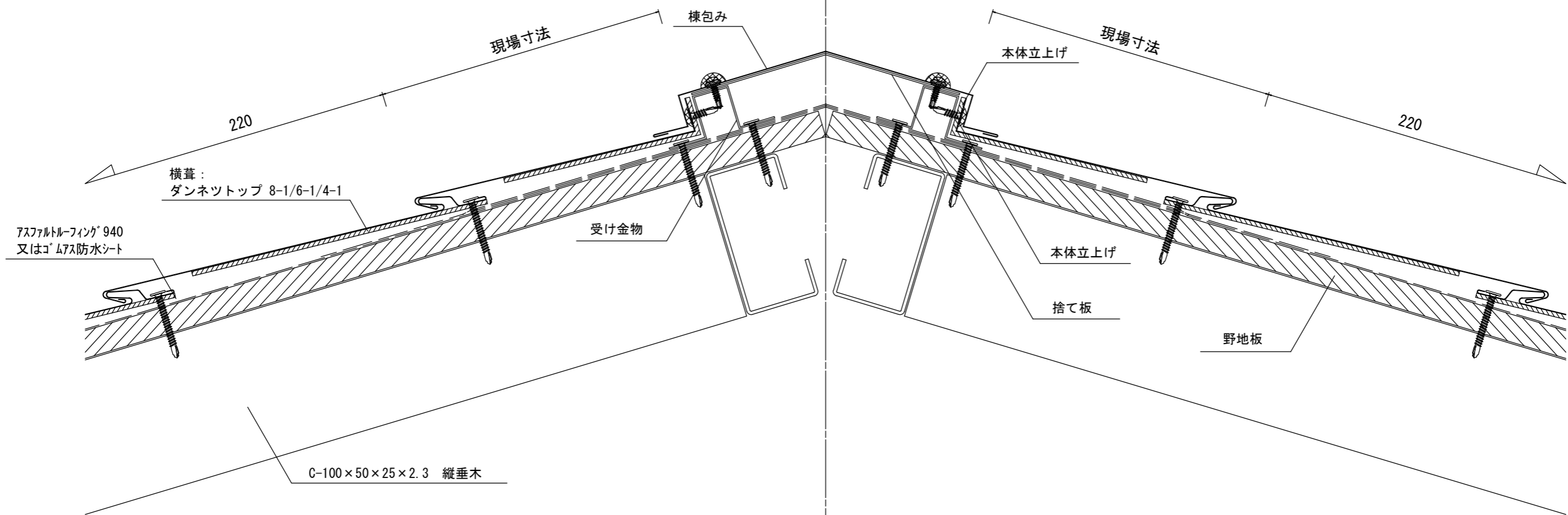
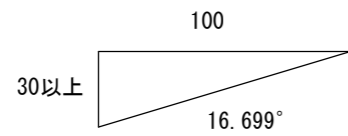

		 セキノ興産				年月日	工事名称	図番
						縮尺 A3: 1/3	図面名 ダンネツトップ 8-1/6-1/4-1 棟部 (鉄骨) 納め	