 セキノ興産				年月日	工事名称 参考納まり図	図番
						縮尺 A3 : 1/2	図面名 ニューS&W工法 軒先部 納め	

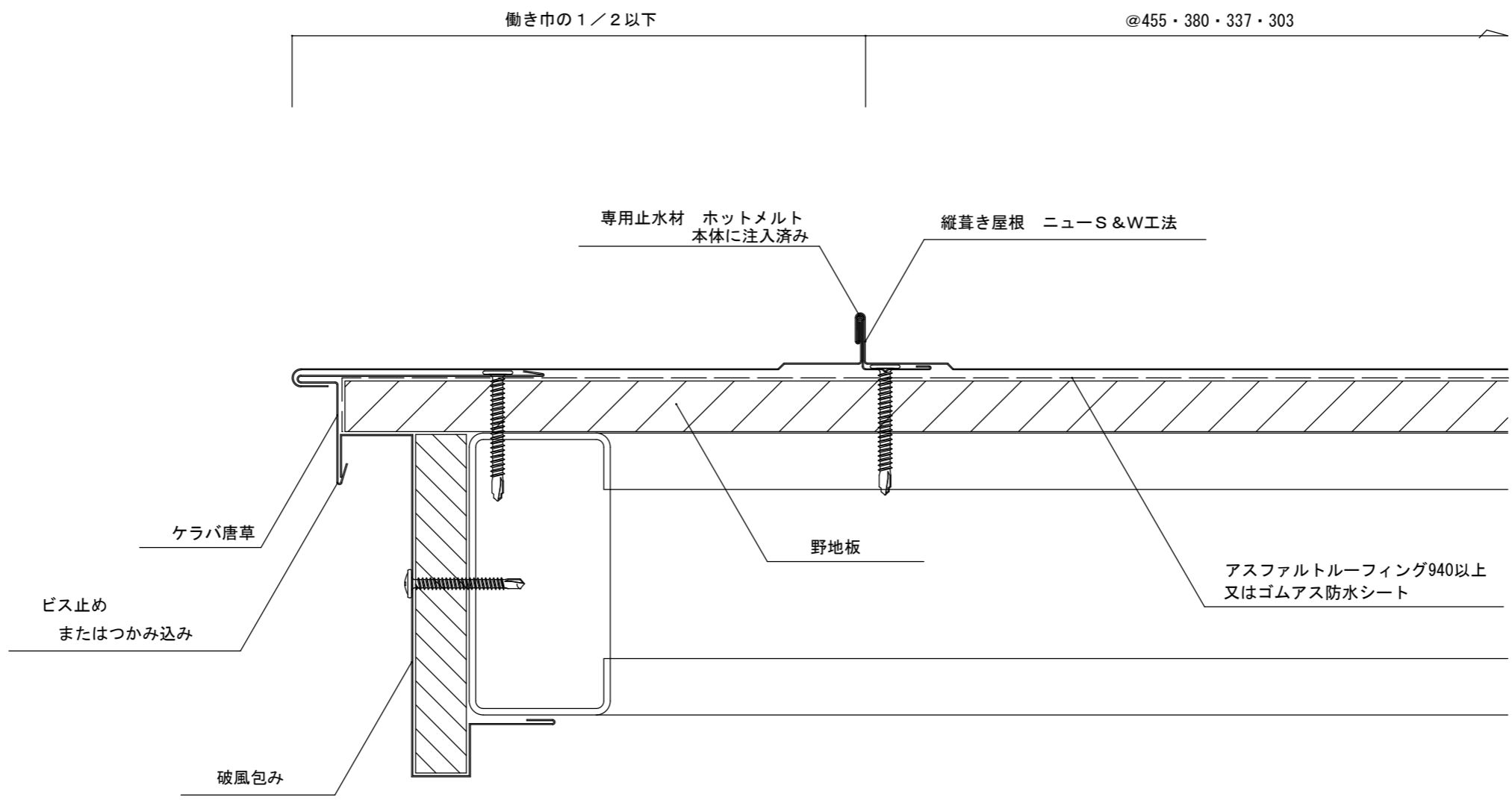

						年月日	工事名称 参考納まり図	図番
						縮尺 A3 : 1/2	図面名 ニューS&W工法 ケラバ部 納め	

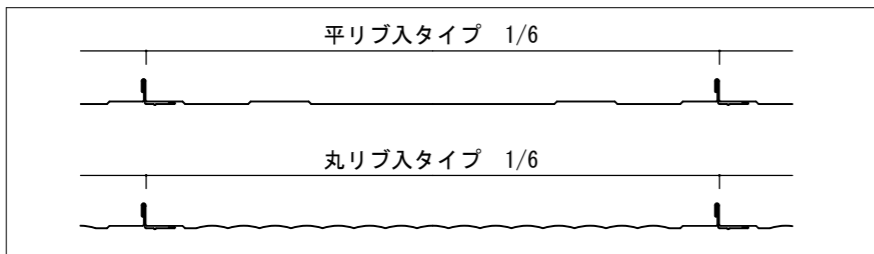

						年月日	工事名称 参考納まり図	図番
						縮尺 A3 : 1/2	図面名 ニューS&W工法 壁取合部 (八千代折り・流れ方向) 納め	

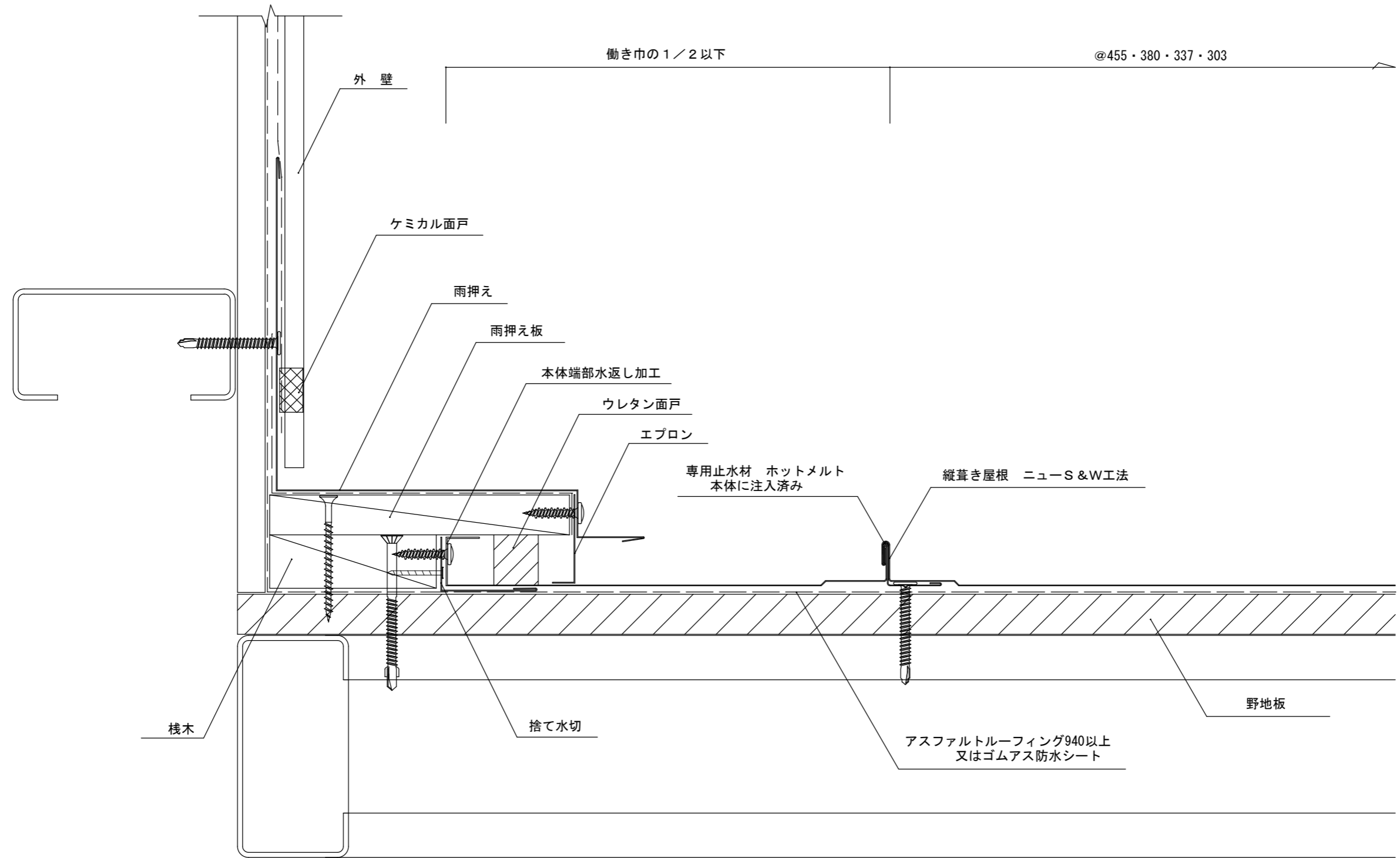
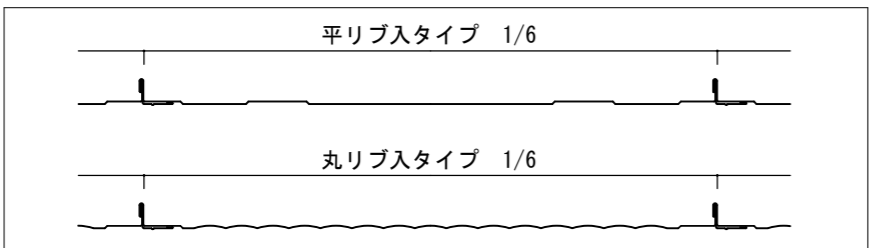
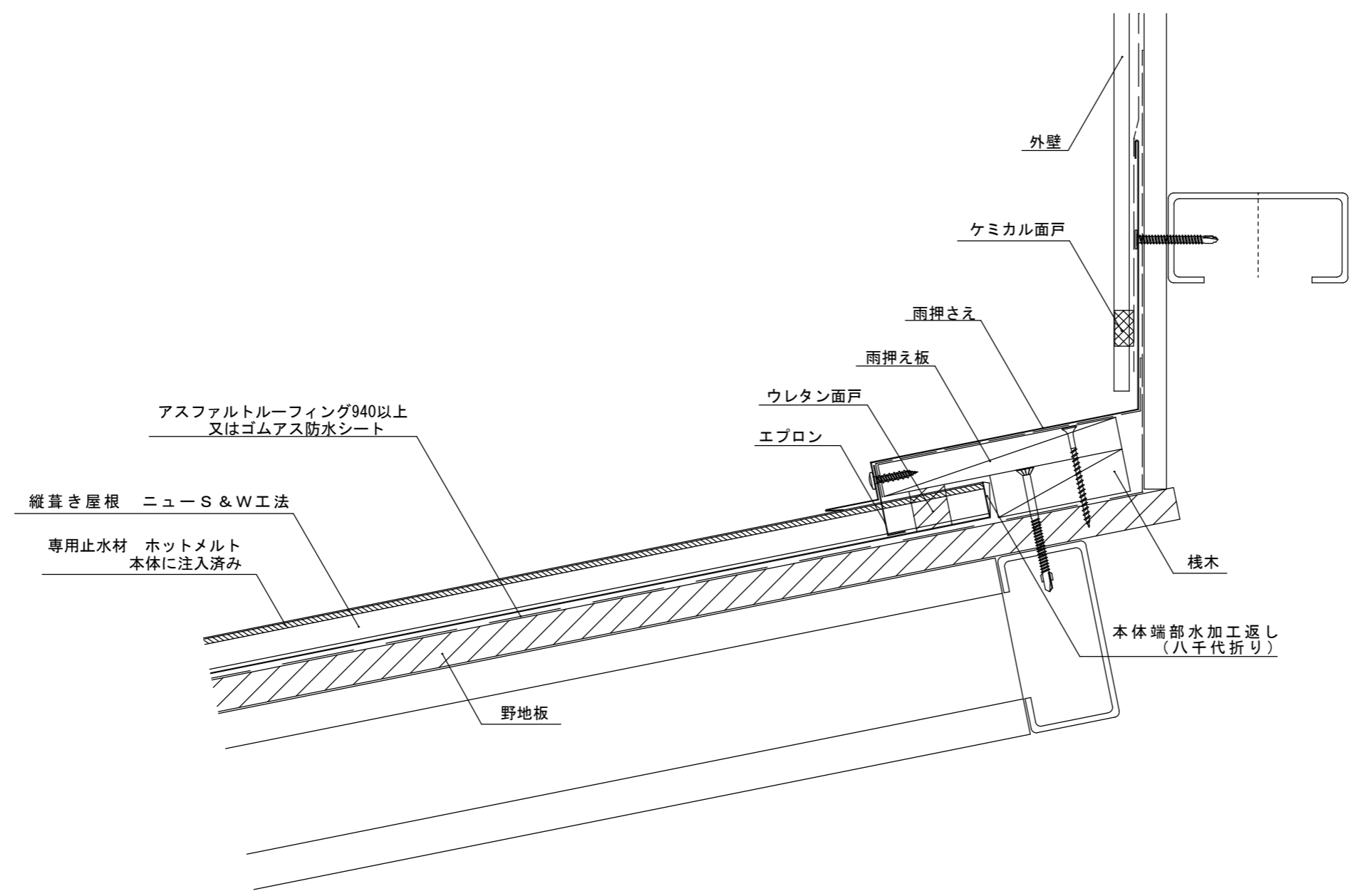
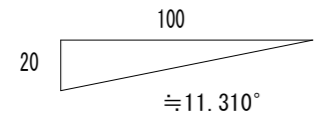

		 セキノ興産				年月日	工事名称 参考納まり図	図番
						縮尺 A3 : 1/3	図面名 ニューS&W工法 壁取合部 (八千代折り・水平方向) 納め	

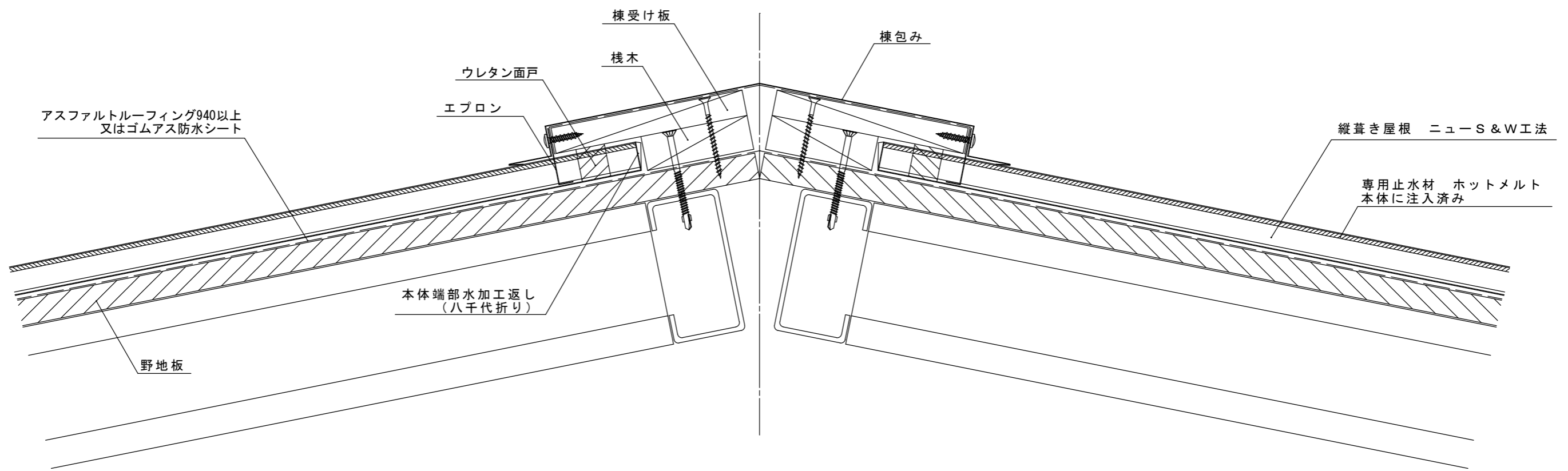
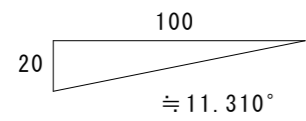

		 セキノ興産				年月日	工事名称 参考納まり図	図番
						縮尺 A3 : 1/3	図面名 ニューS&W工法 棟部 (八千代折り) 納め	

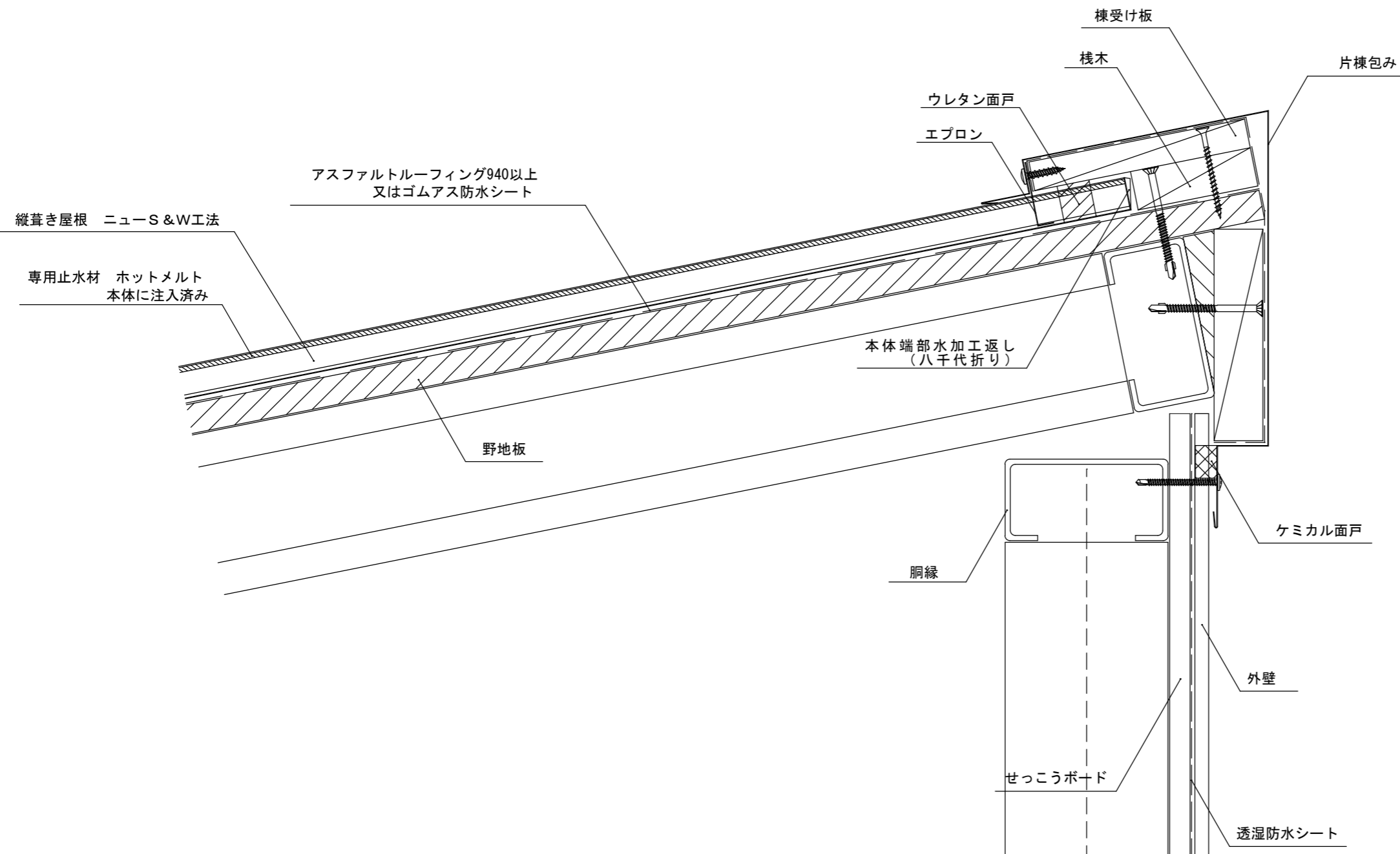
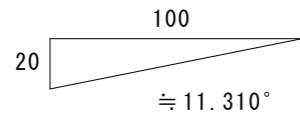

		 セキノ興産				年月日	工事名称 参考納まり図	図番
						縮尺 A3 : 1/3	図面名 ニューS&W工法 片棟部 (八千代折り) 納め	

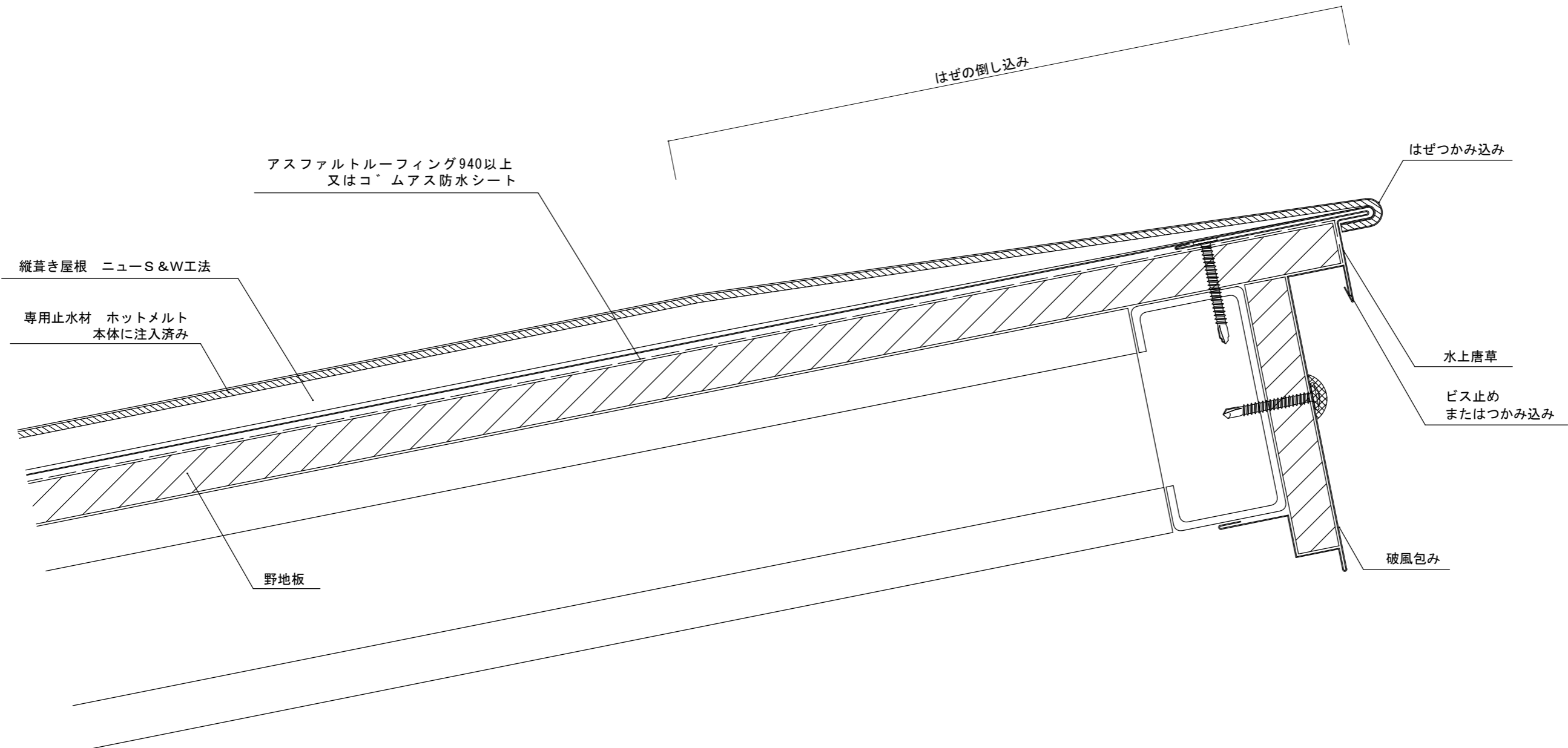
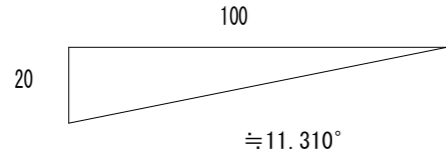

		 セキノ興産				年月日	工事名称 参考納まり図	図番
						縮尺 A3 : 1/2	図面名 ニューS&W工法 水上部 (水上唐草) 納め	